

NEW:
*bigger capacity,
 maximised protection*
 The NEW MediaPlus+ range from Chubb safes has been expertly designed to ensure you have the best protection for your vital data media now with extra capacity.



MediaPlus+

fire resistant data protection

Key features

- Easy slam action emergency closing in event of a fire.
- Generous capacity. Chubb safes cabinets have been designed to give you maximum capacity for today's media.
- Quality media protection.
- 2 hour datamedia protection label. Tested to the highest international standards; UL 72 and EN 1047-1. CEN Norm is certified by ECB.S in class S 120 DIS.
- Low weight ratio due to new advanced fire protection barrier material.
- Ability to customise by using internal fittings to optimise your storage capacity.
- Ability to base fix to the floor for an effective prevention of physical removal.
- The cabinet is fitted with a keylock as a standard. However, you may require the monitoring of access to your sensitive data and therefore we have a series of electronic locks ranging from basic locking to more sophisticated audit trails.
- The cabinet is an attractive light grey which fits in well in most office interiors.



Chubb safes
 Trusted the world over.

DATA
 PROTECTION

Capacity Chart

New FRE DATA platform
 Version: Compact storage

Media designation	Size Dimension (in mm)	Per drawer (level)		Storage	Model									
		Size 1-4	Size 5		Size 1		Size 2		Size 3		Size 4		Size 5	
					no of drawers	total capacity	no of drawers	total capacity	no of drawers	total capacity	no of drawers	total capacity	no of drawers	total capacity
DLT - tapes	110 x 112 x 30	48	94	F + L	4	192	7	336	9	432	13	624	13	1222
LTO tapes	110 x 112 x 30	48	94	F + L	4	192	7	336	9	432	13	624	13	1222
DDS 4 mm (DC 4)	80 x 58 x 16	124	239	F + L	8	992	12	1488	16	1984	22	2728	22	5258
DDS 8 mm (DC 8)	102 x 68 x 20	79	148	F + L	7	553	10	790	14	1106	19	1501	19	2812
DAT Cassettes	80 x 60 x 15	134	260	F + L	8	1072	12	1608	16	2144	22	2948	22	5720
Data Cartridges 3,5"	96 x 100 x 12	144	274	F + L	5	720	7	1008	10	1440	14	2016	14	3836
Data Cartridges 5,25"	141 x 159 x 17	69	130	F	3	207	4	276	6	414	9	621	9	1170
AIT Data Cartridge (Sony)	67 x 112 x 21	108	216	F + L	4	432	7	756	9	972	13	1404	13	2808
Travan Data Cartridge (Sony)	78 x 100 x 19	100	212	F	5	500	7	700	10	1000	14	1400	14	2968
On Stream ADR (Verbatim)	129 x 95 x 15	89	162	F + L	5	445	7	623	10	890	14	1246	14	2268
SLR / MLR 5,25" (Imation)	116 x 161 x 21	54	126	F + L	3	162	4	216	6	324	9	486	9	1134
PD Cartridge (Fuji)	135 x 124 x 8	153	227	F + L	4	612	6	918	8	1224	12	1836	12	2724
IBM 3480 / 3490	127 x 110 x 25	51	99	F + L	4	204	7	357	9	459	13	663	13	1287
CD / DVD (R, RW and RAM)	142 x 124 x 10	117	225	F	4	468	6	702	8	936	12	1404	12	2700
Diskette 3 1/2 (Floppy Disc)	94 x 90 x 3,0	596	1124	F + L	5	2980	8	4768	11	6556	15	8940	15	16860
Optical Disc 3,5	94 x 90 x 6	296	560	F + L	5	1480	8	2368	11	3256	15	4440	15	8400
Optical Disc 5,25	135 x 153 x 11	112	214	F + L	3	336	5	560	6	672	9	1008	9	1926
ZIP Disk Media	103 x 104 x 12	135	256	F + L	5	675	7	945	10	1350	14	1890	14	3584
MO - R/W (Magneto Optical Disk)	157 x 143 x 16	62	122	F + L	3	186	5	310	7	434	10	620	10	1220

F = frontal loading

F + L = frontal and lateral loading

Internal Fittings

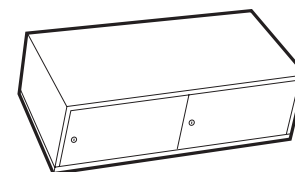

Lockable cupboard (size 5)

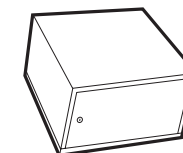

Lockable cupboard



Adjustable shelf

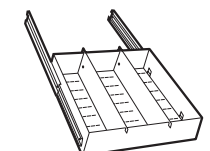

pull out drawers
 (with dividers)

Authorised dealer:

Chubb safes

Trusted the world over.

PO Box 61, Woden Road, Wolverhampton, WV10 0BY United Kingdom
 Tel. +44 (0) 1902 455111 Fax: +44 (0) 1902 351961

Email: marketing@chubbsafesuk.com

Website: www.chubbsafes.co.uk

'Chubb' is owned by Chubb plc and is a registered trademark used under license

Product specifications

Model	External dimensions (mm)			Internal dimensions (mm)			Internal Vol (litres)	Weight* (kg)	Fittings		
	Height	Width	Depth***	Height	Width	Depth			Adjustable shelf	Pullout drawer	Lockable cupboard
MediaPlus+ Size 1	911	746	780	565	490	400	111	315	•	•	•
Size 2	1191	746	780	845	490	400	167	390	•	•	•
Size 3	1471	746	780	1125	490	400	221	490	•	•	•
Size 4	1941	746	780	1595	490	400	313	640	•	•	•
Size 5	1941	1036	830	1570	780	450	556	860	•	•	**

* Weight refers to an empty cabinet

** A double cupboard is only available in size 5

*** External depth is gross measurement incl. 60mm for handle which can be removed for installation

All information supplied was accurate at the time of printing, however, Chubb safes reserves the right to make any modifications.

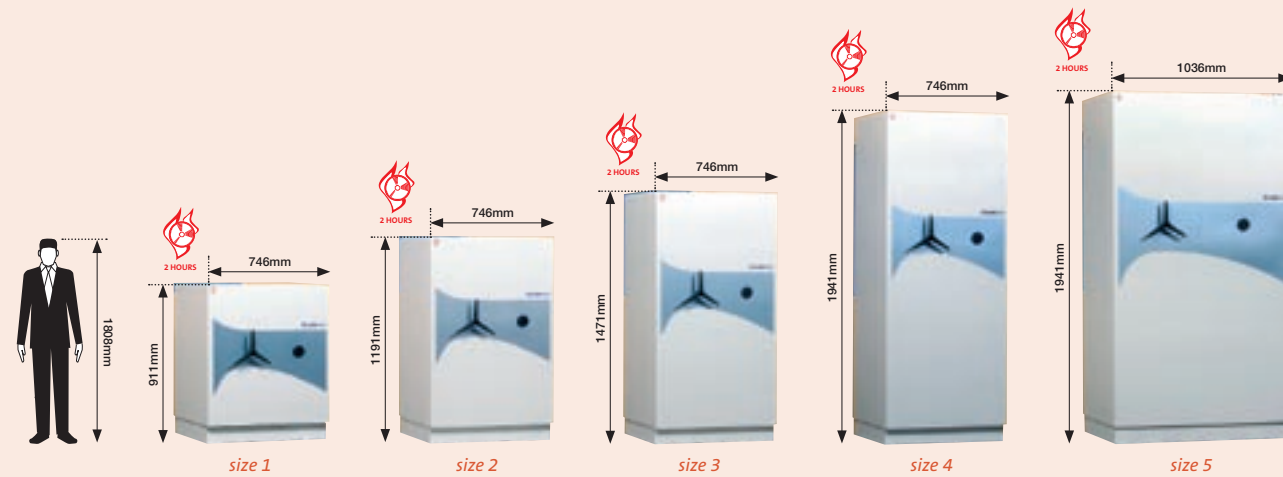

Installation Guide

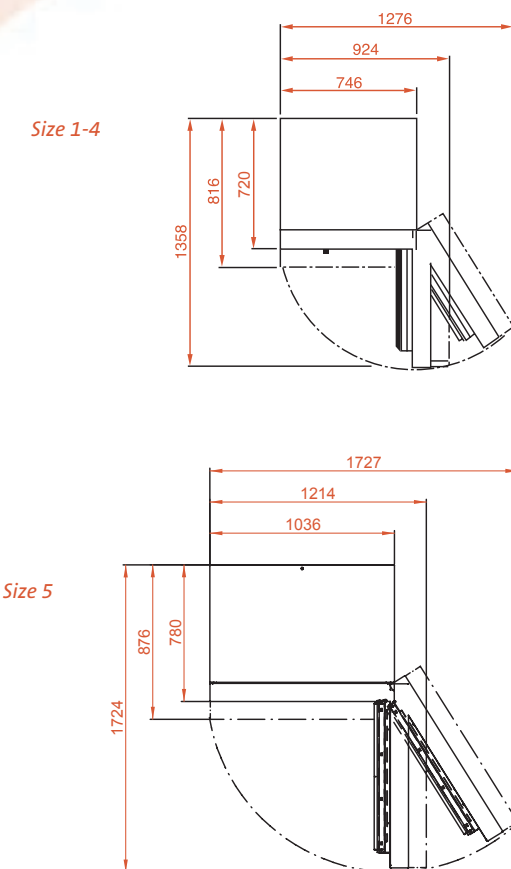

Locking Options



Testing

Part 1: EN 1047-1, UL- 72 and NT 017 FIRE tests.

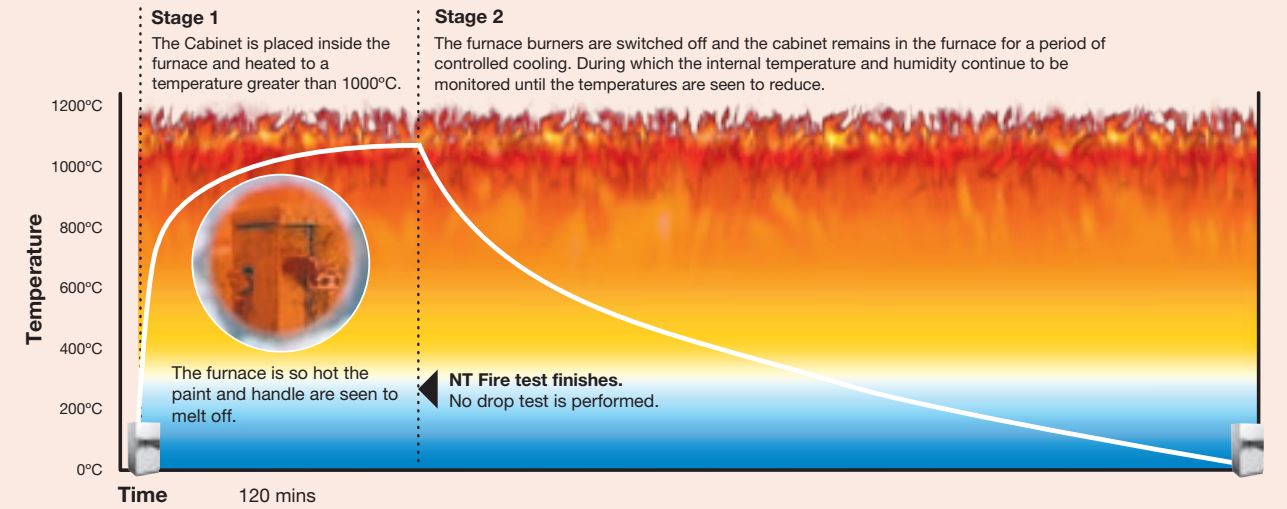

As the cabinet is affected by heat for a much longer time, the testing period can actually take up to 24 hours.

Part 2: EN 1047-1, UL-72

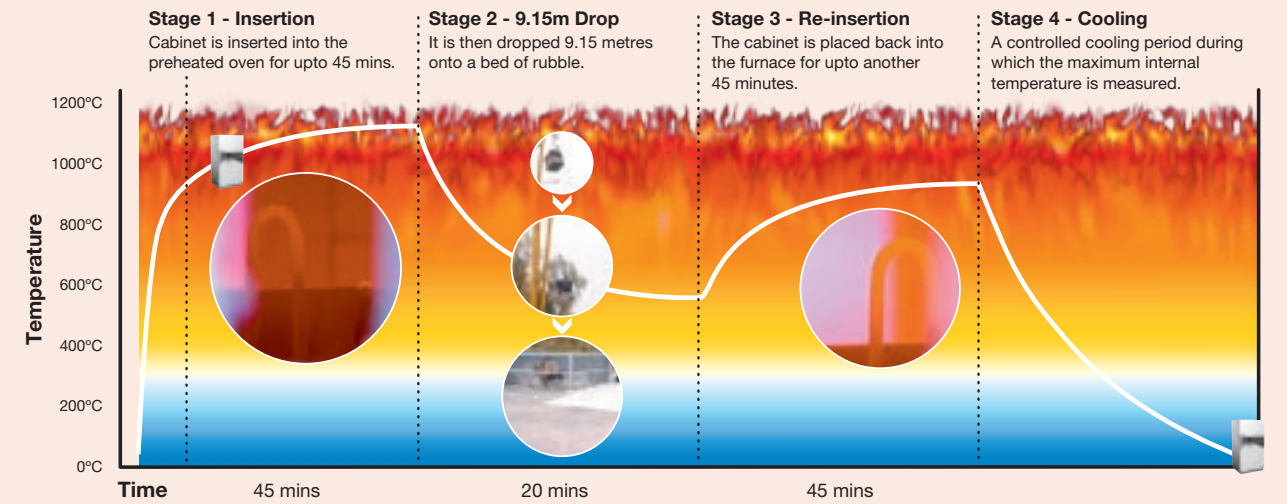

As the cabinet is affected by heat for a much longer time, the testing period can actually take up to 24 hours.

Consequences of a fire

The furnace is so hot the paint and handles are seen to melt off.

Below illustrates the devastation caused after a fire. Imagine what would be left of your vital data media if it were not stored in a Chubb safes' cabinet.



The result of an office fire



Punch area
DO NOT PRINT

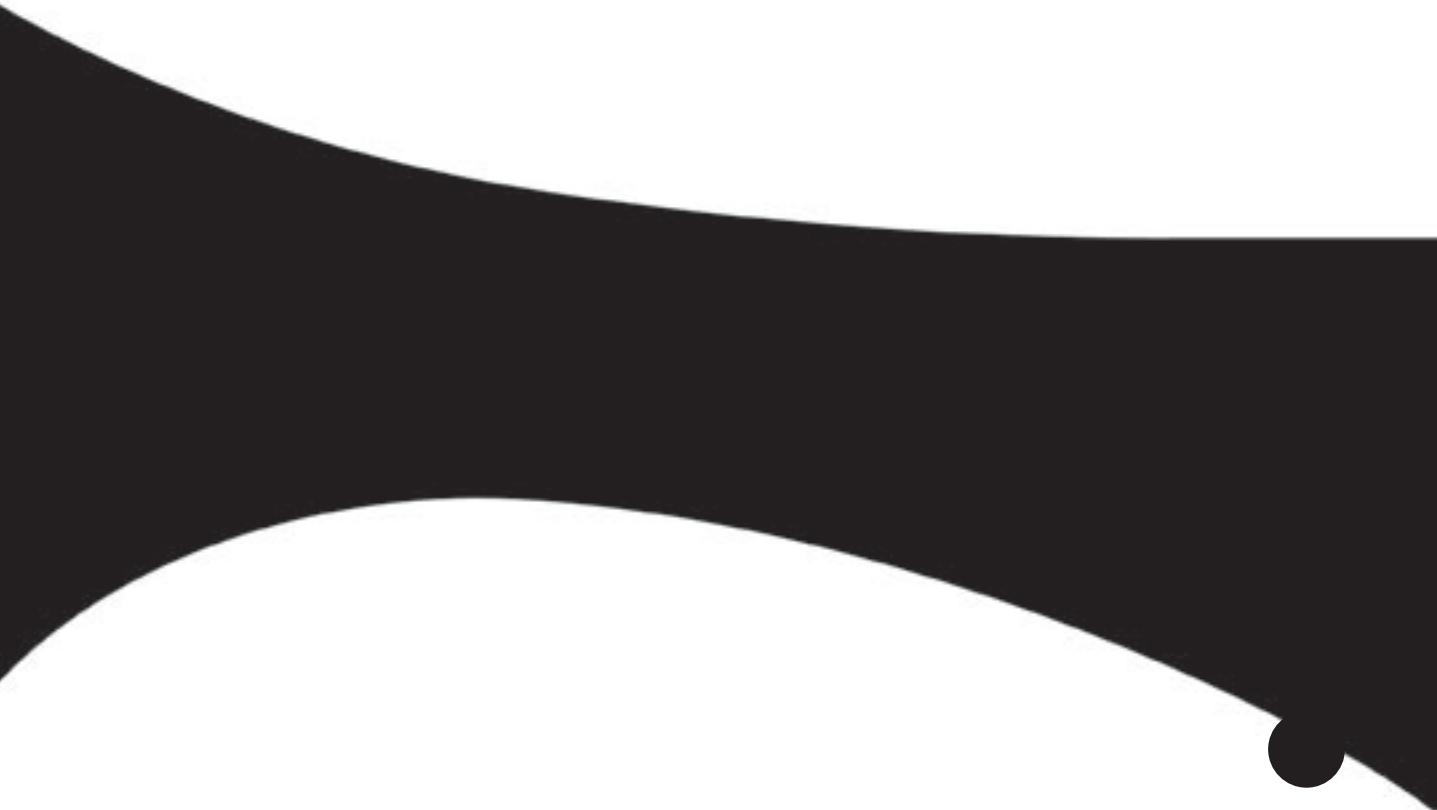

Chubbsafes
Trusted the world over.

Chubbsafes
Trusted the world over.